

Quick Start Guide

# Rvolution

PlayerPro 8K **TV**

English

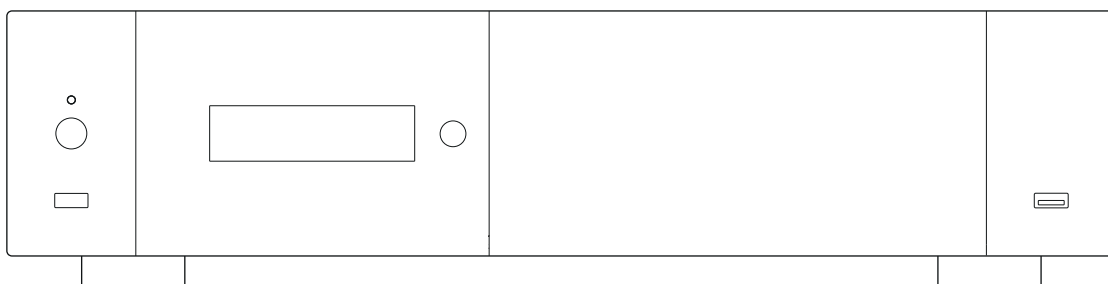

## Important Safety Instructions

- 1) Read and keep these instructions.
- 2) Heed all warnings.
- 3) Follow all instructions.
- 4) Do not use this apparatus near water.
- 5) Clean only with dry cloth.
- 6) Do not block any ventilation openings.
- 7) Do not install near any heat sources such as radiators, heat registers, stoves, or other apparatus (including amplifiers) that produce heat.

## WARNING:

TO REDUCE THE RISK OF FIRE OR ELECTRIC SHOCK, DO NOT EXPOSE THIS APPLIANCE TO RAIN OR MOISTURE. DANGEROUS HIGH VOLTAGES ARE PRESENT INSIDE THE ENCLOSURE. DO NOT OPEN THE CABINET. REFER SERVICING TO QUALIFIED PERSONNEL ONLY.

THE APPARATUS SHALL NOT BE EXPOSED TO DRIPPING OR SPLASHING AND THAT NO OBJECTS FILLED WITH LIQUIDS, SUCH AS VASES SHALL BE PLACED ON THE APPARATUS.



### Warning:

This equipment has been tested and found to comply with the limits for a Class B digital device, pursuant to part 15 of the FCC Rules. These limits are designed to provide reasonable protection against harmful interference in a residential installation. This equipment generates, uses and can radiate radio frequency energy and, if not installed and used in accordance with the instructions, may cause harmful interference to radio communications. However, there is no guarantee that interference will not occur in a particular installation. If this equipment does cause harmful interference to radio or television reception, which can be determined by turning the equipment off and on, the user is encouraged to try to correct the interference by one or more of the following measures:

- Reorient or relocate the receiving antenna.
- Increase the separation between the equipment and receiver.
- Connect the equipment into an outlet on a circuit different from that to which the receiver is connected.
- Consult the dealer or an experienced radio/TV technician for help.

**Caution:** Any changes or modifications to this device not explicitly approved by manufacturer could void your authority to operate this equipment.

This device complies with part 15 of the FCC Rules. Operation is subject to the following two conditions: (1) This device may not cause harmful interference, and (2) this device must accept any interference received, including interference that may cause undesired operation.

## Getting More Information

Due to the regular evolution and the addition of new functionalities, provided by firmware and software updates, it is impossible to cover all functionalities in this user's guide. For this reason, we invite you to visit our online **R\_volution Knowledge Base**. You will find a large amount of tutorials and various help topics concerning the use of the media player and R\_volution applications:

[rvolution.com/knowledgebase](http://rvolution.com/knowledgebase)

## About R\_volution

R\_volution designs and manufactures only professional grade Video Management Systems; delivering the highest quality, outstanding performance, and best possible user experience.

All our products are designed to provide our end-user customers with convenient and intuitive access to their entire movie library collection, in stunning 4K, High Definition resolution. R\_volution devices are made to improve the movie watching experience, in residential and commercial environments.

To ensure the ultimate performance, all R\_volution devices are supplied to authorized resellers through a worldwide network of established and well respected partners.

More info: [rvolution.com](http://rvolution.com)



### WEEE symbol

Correct Disposal of This Product. (Waste Electrical & Electronic Equipment) Applicable in the European Union and other European countries with separate collection systems.

This marking on the product, accessories or literature indicates that the product and its electronic accessories (remote handset) should not be disposed of with other household waste at the end of their working life. To prevent possible harm to the environment or human health from uncontrolled waste disposal, please separate these items from other types of household waste and recycle them responsibly to promote the sustainable reuse of material resources.

More info can be found here:

<http://ec.europa.eu>

## CAUTION:

DANGER OF EXPLOSION IF BATTERY IS INCORRECTLY REPLACED. REPLACE ONLY WITH THE SAME OR EQUIVALENT TYPE. DO NOT OPEN COVERS AND DO NOT REPAIR YOURSELF. REFER SERVICING TO QUALIFIED PERSONNEL.



This product complies with European Low Voltage (2006/95/CE), Electromagnetic Compatibility (2004/108/EC) and Environmentally-friendly design of Energy-related Products (2009/125/EC) Directives when used and installed according to this instruction manual.

## Table of Contents

### English Quick Start Guide

---

- 2 • Box Contents
- 3 • External Views of the Device
- 4 • Main Remote Control
- 5 • Android TV Remote Control • Home Automation (IR / IP Control)
- 6 • Connecting the Player to a TV Without a Home Cinema Amplifier
- 6 • Connecting the Player Through a Home Cinema Amplifier
- 7 • Dual HDMI Output • Dual HDMI Input
- 8 • Digital Audio S/PDIF Optical and Coaxial • Headphones
- 9 • Ethernet • Network Switch • Wi-Fi • Ground Connection
- 10 • Connecting a NAS
- 11 • Inserting, Formatting, and Using a Hard Drive
- 12 • Startup • Audio Settings • Video Settings
- 13 • Android TV Initialization
- 14 • Explorer • R\_video • Creating an R\_video Account
- 15 • Network Access
- 15 • File Transfers
- 15 • Slideshow Function
- 15 • Playback Options
- 15 • Installing an Android App
- 16 • How to Create a Movie Collection in R\_video
- 17 • R\_video Home Page
- 17 • Identifying a Movie or Series • Deleting a Movie or Episode
- 18 • Identifying Unrecognized Movies and Episodes • Banners
- 18 • Changing an Image (Poster or Background)
- 18 • Multiple Hard Drives
- 19 • Parental Control • Custom Categories
- 19 • Launching R\_video at Startup • Filters and Sorting
- 19 • Search Engine • Sagas and Groups
- 20 • Subtitle Display Options During Playback
- 20 • Subtitle Download Options
- 20 • Video Zoom and Aspect Ratio Settings
- 20 • Technical Information During Playback
- 20 • R\_video Collection Statistics
- 20 • Adding a Category to the Left Sidebar
- 21 • Firmware Update
- 21 • Factory Reset and Firmware Restoration



Manufactured under license from Dolby Laboratories.  
Dolby and the double-D symbol are trademarks of Dolby Laboratories.



DTS, the Symbol, & DTS and the Symbol together are registered trademarks & DTS 2.0+Digital Out is a trademark of DTS, Inc. Product includes software. © DTS, Inc. All Rights Reserved.

## Package Contents



**NOTE:** Additional accessories and cables may be included depending on your region.

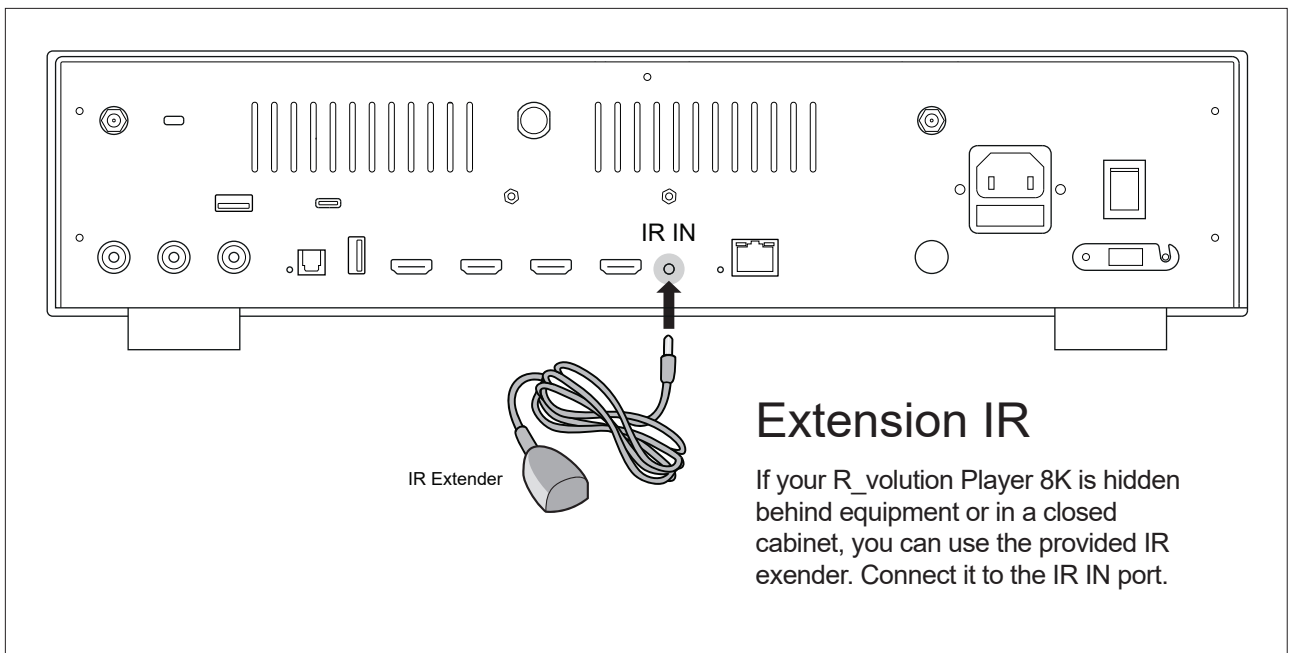

**NOTE:** The R\_volution PlayerPro 8K TV remote control supports Bluetooth in addition to IR. To enable Bluetooth on the remote, please follow the instructions on page 7.

## Front View

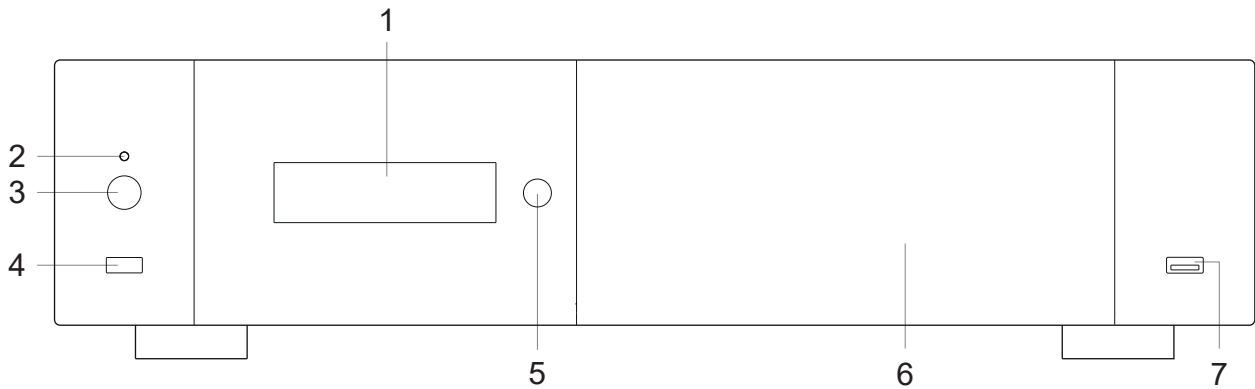

- |                   |                |                                |
|-------------------|----------------|--------------------------------|
| 1. LCD Screen     | 4. HDMI Switch | 6. Internal Dual HDD Rack Door |
| 2. Power LED      | 5. IR Sensor   | 7. USB Host                    |
| 3. POWER ON/Sleep |                |                                |

## Rear View

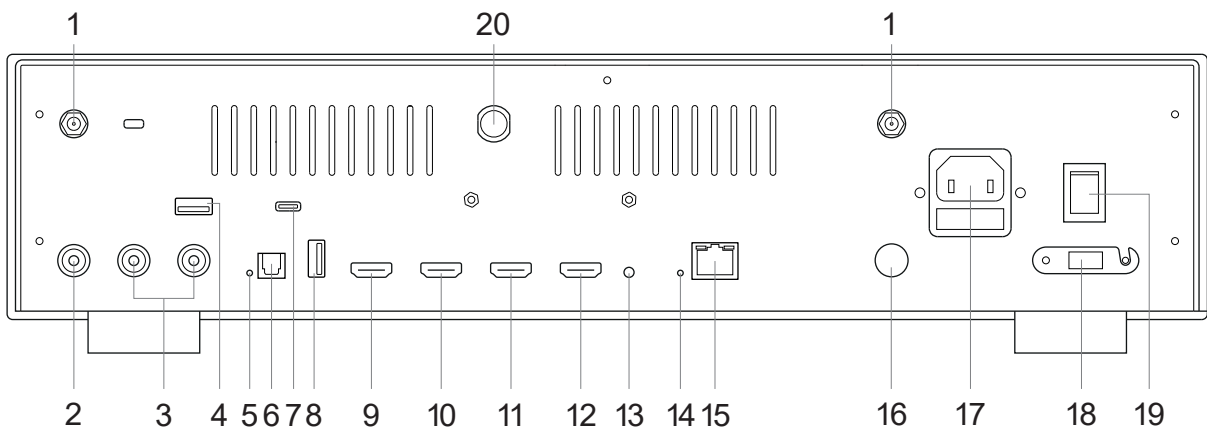

- |                                       |   |
|---------------------------------------|---|
| 1. Wi-Fi Antenna                      | 11. HDMI Input  |
| 2. Coaxial Digital Audio Output       | 12. HDMI Input  |
| 3. RCA Analog Audio Output            | 13. IR IN (IR extender included)                              |
| 4. USB Port Dedicated to TV Recording | 14. Main Reset Button   |
| 5. Android TV Reset Button            | 15. LAN 10/100/1000 (Ethernet)                                |
| 6. Optical Digital Audio Output       | 16. Ground Connection (Earth)                                 |
| 7. Optional DVB-T Antenna*            | 17. Power Connector   |
| 8. Low-Noise USB Audio Output         | 18. Voltage Selector  |
| 9. HDMI Audio-Only Output             | 19. ON/OFF Power Switch                                       |
| 10. HDMI 2.1a Audio + Video Output    | 20. RF Antenna (required to control the player via Bluetooth) |

### **\*WARNING!**

Do not connect a USB flash drive to this port!



## Android TV Remote Control

This remote control is used only for the initial setup of the **Android TV** system. Once **Android TV** has been configured, you will no longer need this remote: the entire system can be operated with the main remote control, both for multimedia playback under Android and for **streaming apps** on Android TV.

The secondary remote can still be used within the Android TV interface, but it currently cannot return to the Android section dedicated to multimedia playback, the Explorer, or the R\_video application.

1. **ON/OFF:** Turn the device on or off.
2. **EXIT:** Leave Android TV.
3. **MIC:** Voice search.
4. **FAVORITES:** Add an item to Favorites.
5. **SETTINGS:** Access Android TV settings.
6. **ARROWS:** Navigate up, down, left, right.
7. **OK:** Confirm an option or enter a selected item.
8. **BACK:** Return to the previous menu.
9. **HOME:** Go to the home screen.
10. **TV:** Switch to the TV tuner (optional external tuner).
11. **MUTE:** Mute / unmute audio.
12. **CH+ / CH-:** Change TV channels (tuner).
13. **VOLUME + / -:** Adjust the volume.
14. **YOUTUBE:** Direct access to the YouTube app.
15. **NETFLIX:** Direct access to the Netflix app.
16. **PRIME VIDEO:** Direct access to the Prime Video app.
17. **SHORTCUT:** Direct access to a custom application.  
To configure this button, press it: a list of apps will appear on the right side of the screen. Simply select the app you want to assign by pressing OK on it.

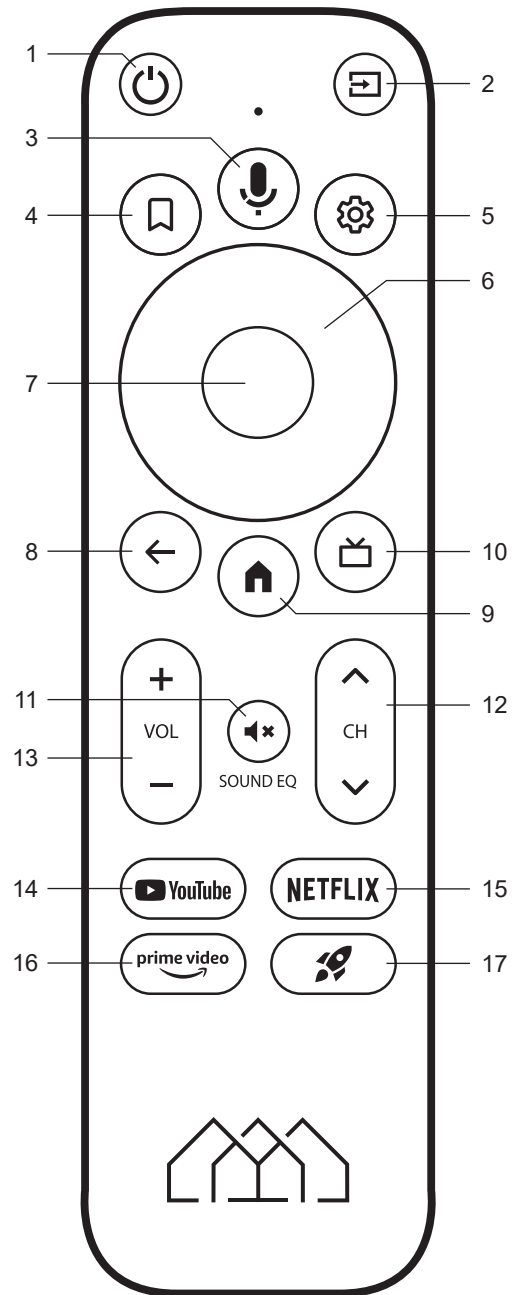

## Using the Remote Control

Within about  
26 ft (8m)

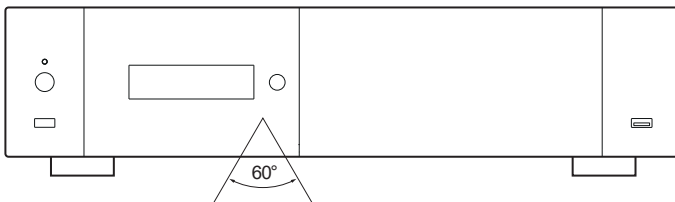

When using the remote control, the front window of the remote control should be pointed to the infrared sensor on the front panel within an angle of  $\pm 60^\circ$  and a range of about 26 ft.

*Please use alkaline batteries.  
Please observe polarity when inserting batteries.*

## Third Party Control

You can control your R\_volution player using third party devices such as Control4, Crestron, RTI, ProControl, Savant, Logitech, Elan...

**More info:**  
[rvolution.com/knowledgebase](http://rvolution.com/knowledgebase)

## Connecting your Player to your TV without AV Receiver

If you lack a home theater receiver or soundbar, the simplest method is to link your player straight to your TV. Achieve this by plugging the HDMI output from your media player into an available HDMI port on your TV. Should you possess a stereo amplifier, you can connect it to the player's RCA analog outputs with an RCA cable for enhanced audio quality.

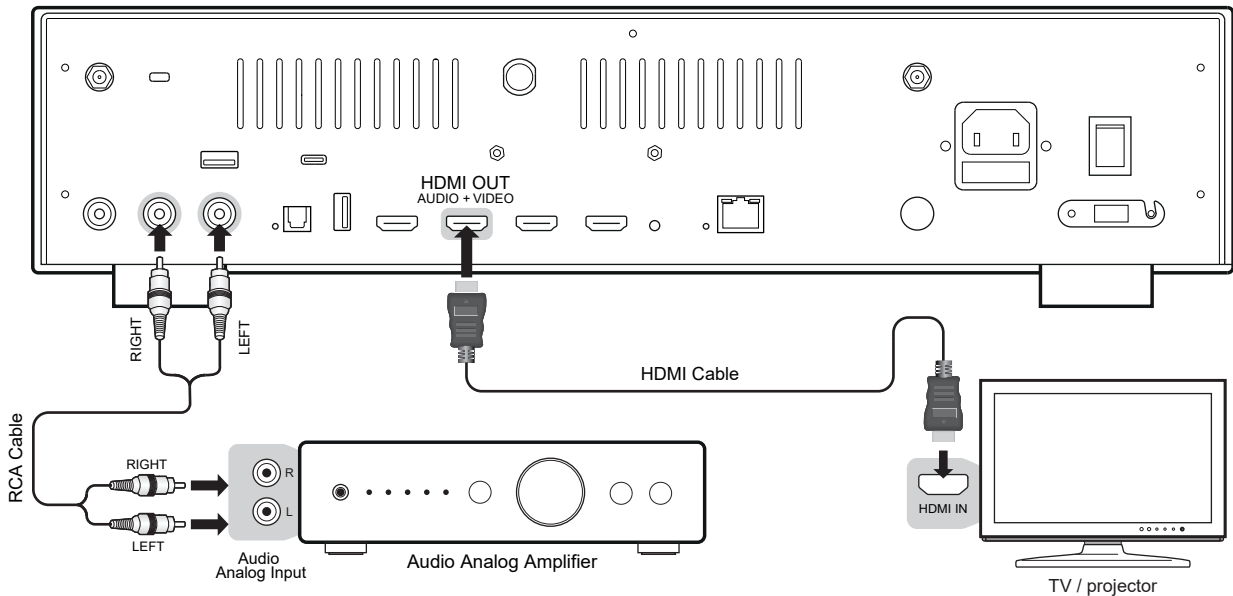

## Connecting your Player to your TV through AV Receiver

If you own an AV receiver, the most convenient and easiest way is to connect your media player to your TV through your AV receiver or soundbar. To do this, connect the HDMI Main output of your media player to a free HDMI input on your AV receiver. Then connect the HDMI output of your AV receiver to your TV or front projector. If your TV is compatible with 8K HDR, your AV receiver must also be compatible with 8K HDR. Otherwise, please use the S/PDIF optical output as explained on the next page.

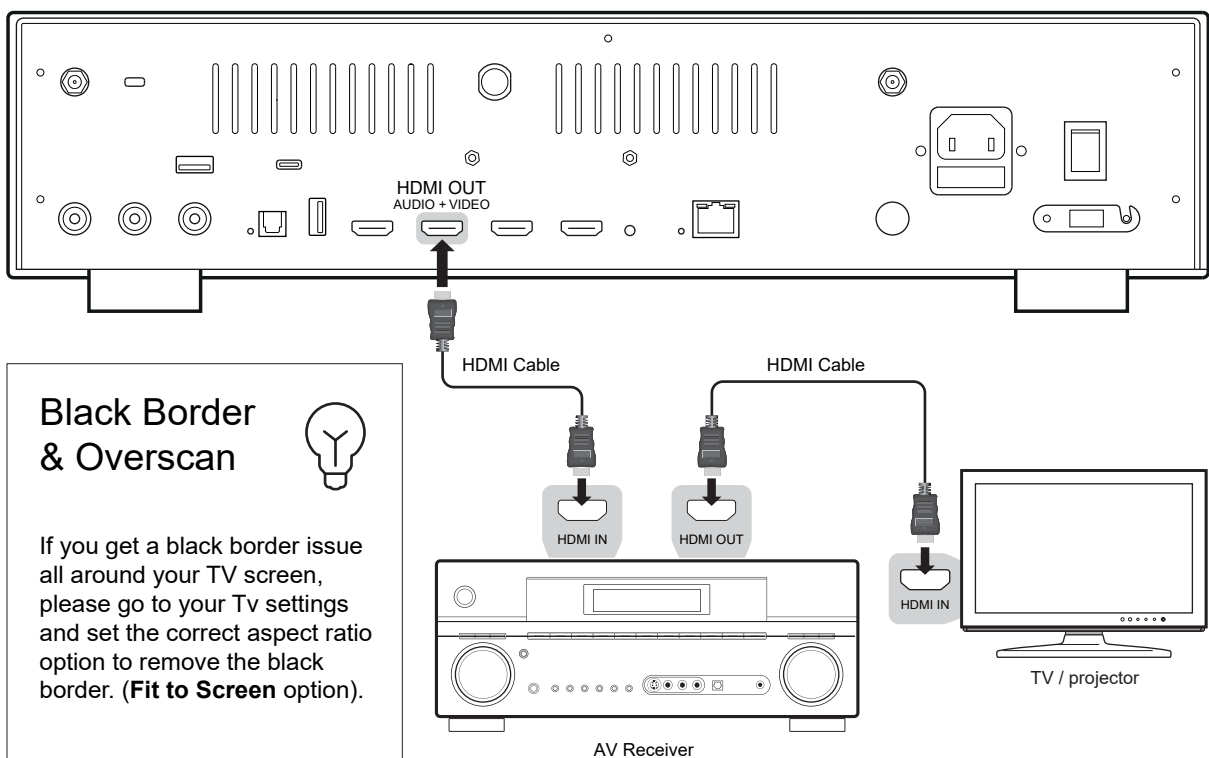

## Utiliser la double sortie HDMI

If your home theater amplifier or soundbar is not compatible with 4K or 8K, but your TV or projector is, you can use the **dual HDMI outputs** to separate audio and video. Connect the **Main HDMI output** (Video + Audio) to your TV or projector, then connect the **Audio-Only HDMI output** to your amplifier. If your amplifier is a recent model, we recommend using only the Main HDMI output, which allows you to benefit from **LipSync**.

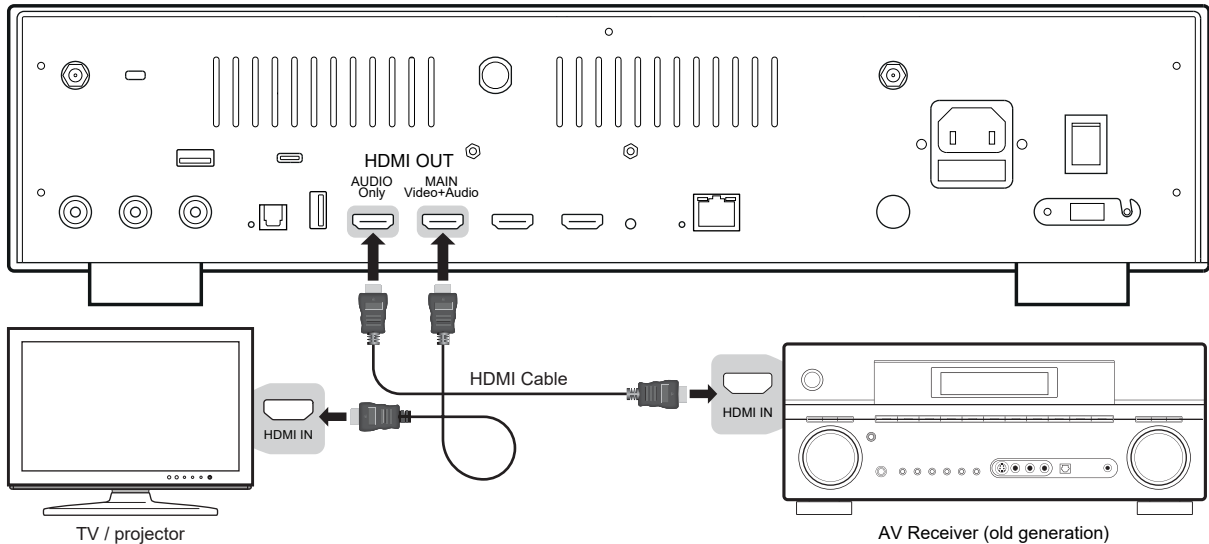

## Using the HDMI Inputs

The player includes **two HDMI inputs** that function as a switch, allowing you to pass through a signal from external sources. Simply connect your devices to **HDMI INPUT 1** or **HDMI INPUT 2**.

To select one of these sources, use the button located on the front panel, at the bottom left under the **POWER button** (see page 3). You can also access your sources from the player's interface: **Apps > HDMI INPUT 1** or **HDMI INPUT 2**, in order to switch the video signal.

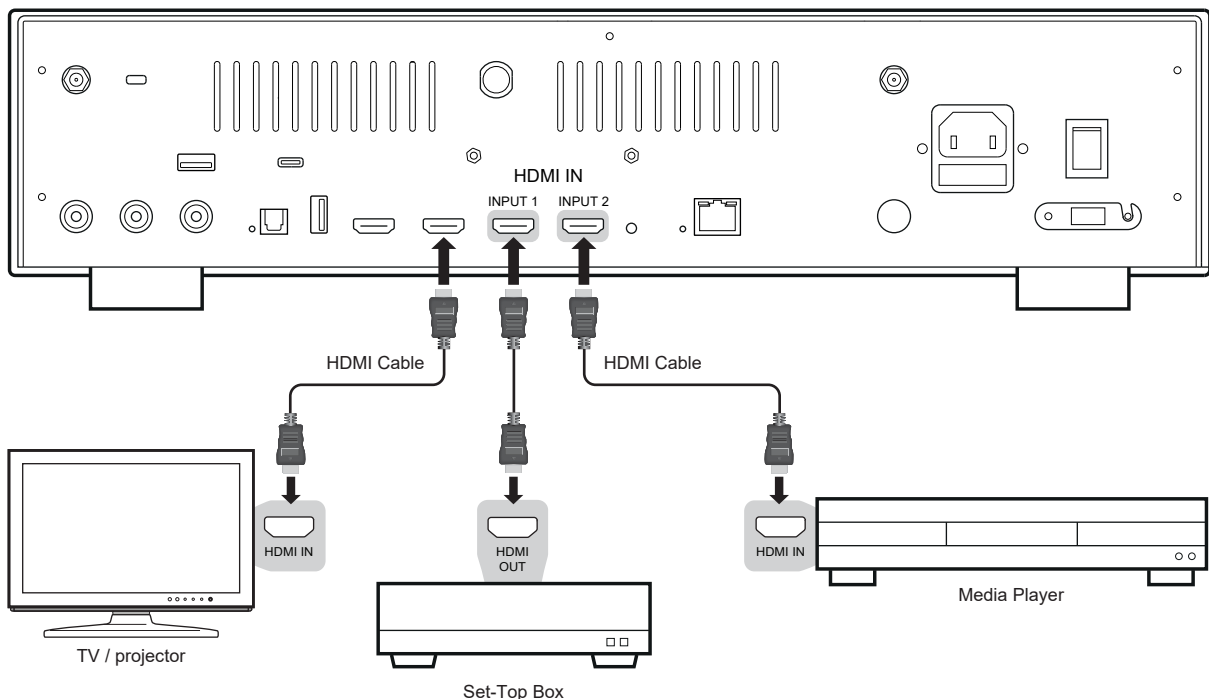

## Audio Digital S/PDIF Optical and Coaxial

If your AV receiver is not compatible with HDMI, you can connect your player to your AV receiver using S/PDIF optical (TOS-link) or coaxial digital output as follows:

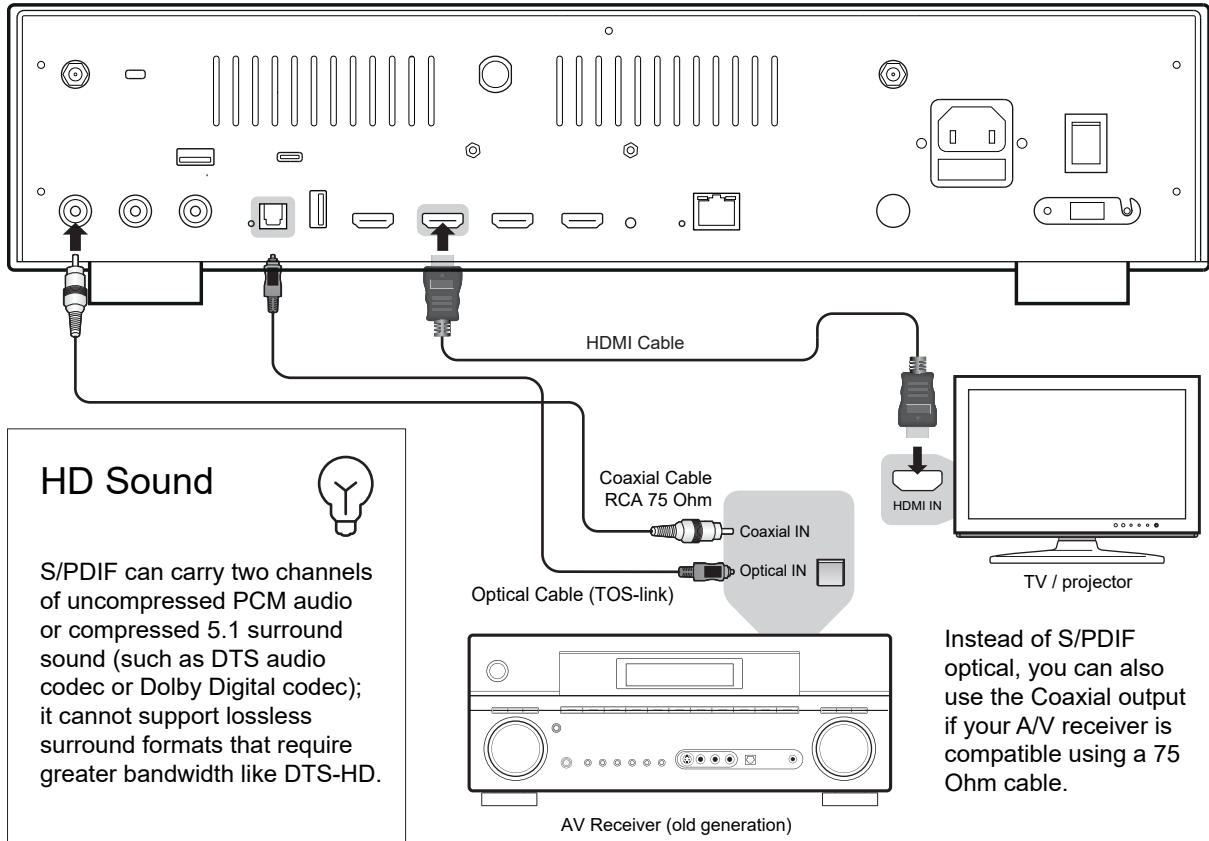

## Headphones

If you have a pair of **headphones**, connect the HDMI output to your TV and use an RCA-to-3.5 mm female mini-jack adapter to connect your headphones to your Revolution media player. Then set your TV's volume to minimum or activate its MUTE function to avoid audio duplication.

You can also use wireless Bluetooth headphones.

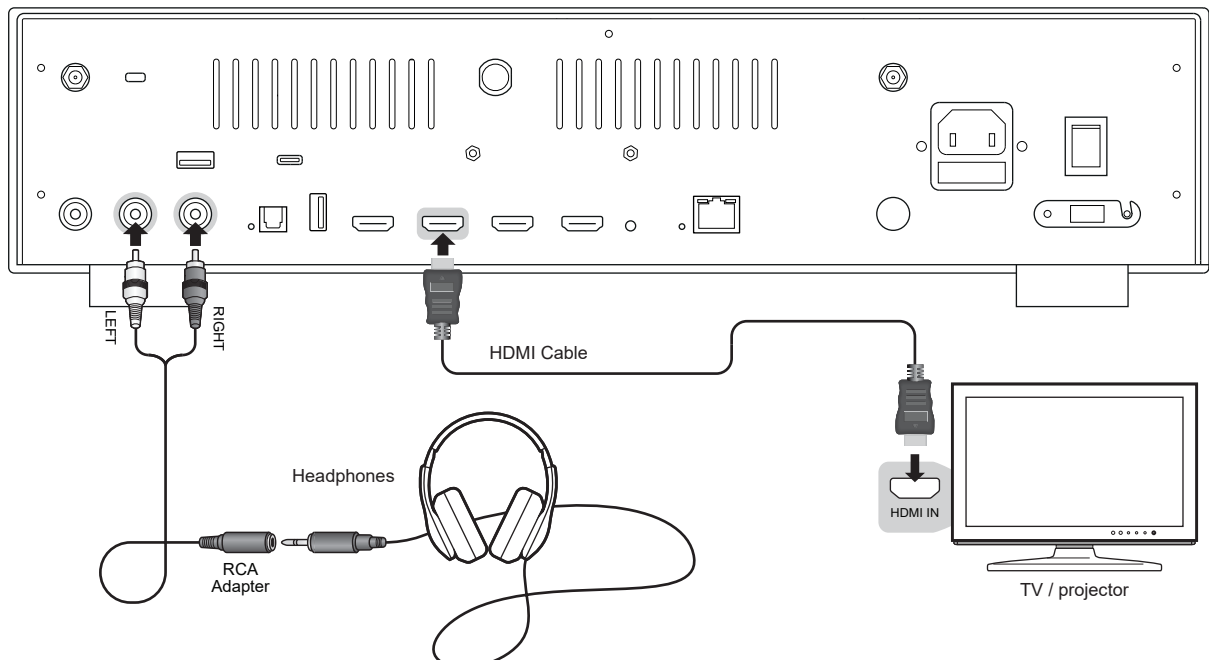

## Ethernet

The media player provides two network connection methods: through **Ethernet cable** or through the built-in wireless LAN adapter. For the fastest and most stable network connection, we recommend using an Ethernet cable whenever possible. Plug one end of a **network cable** (straight Ethernet cable) into the **LAN port** on the back of the media player (Category 5E or more). Then, plug the other end of the network cable into a LAN port on the broadband router or modem (or switch if you use one).

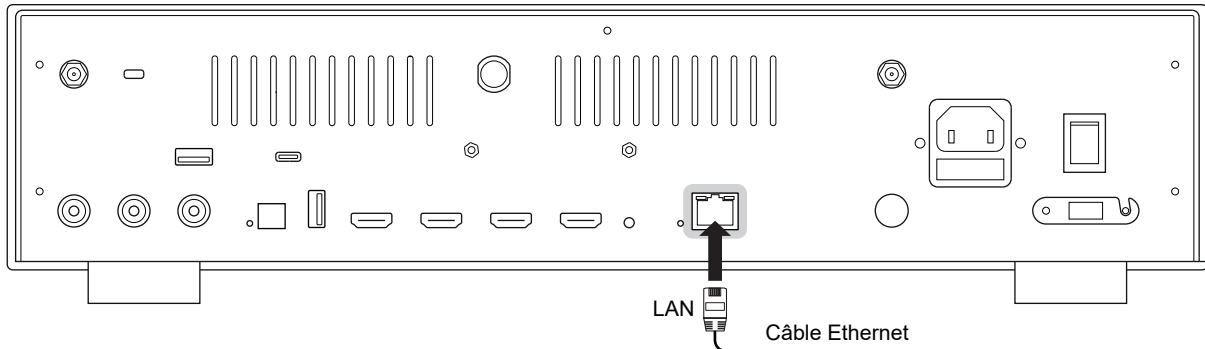

## Ethernet Switch

For better result, we advise the use high-fidelity switch.

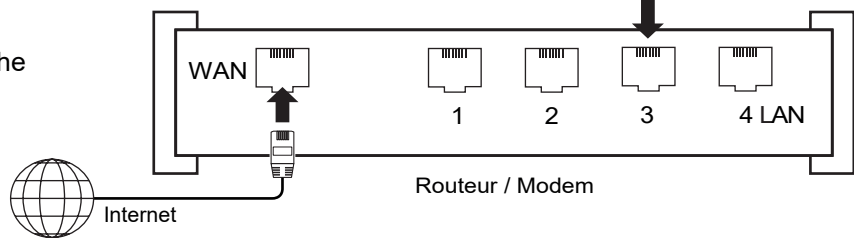

## Wi-Fi

To setup the wireless feature, start by connecting the antennas to the Wi-Fi connectors on the back of the media player. Then, turn on your media player and go to: **Setup > Network > Wireless connection (Wi-Fi)**. Then click on Edit settings. You will be able to select a wireless network and enter the security password.

## Terre (Ground)

The **grounding connector** on the player—often referred to as the grounding terminal—is used to establish a connection between the device and an external grounding system. Its purpose is to dissipate any static electricity or electrical interference that may build up on the unit, helping maintain optimal audio and video performance. Obtain a **grounding cable**, typically a wire with a ring terminal on one end. Make sure the cable is long enough to reach the grounding point or system you plan to connect it to. This may be a dedicated **grounding terminal**, a grounding rod, or another component in your audio/video setup equipped with a grounding connector.

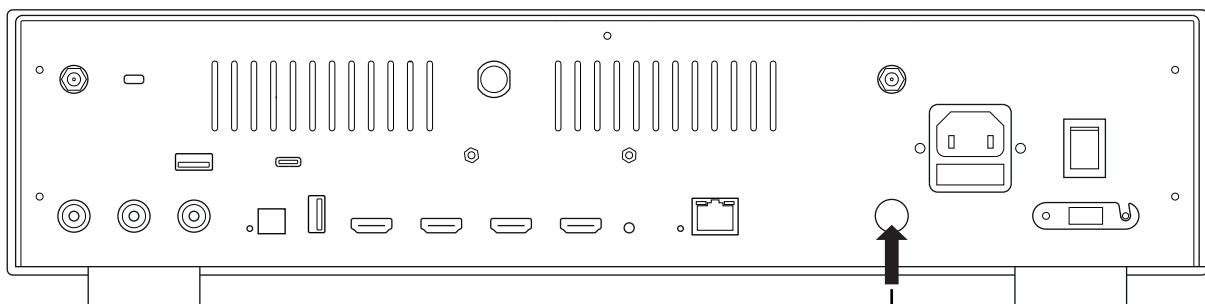

*Before proceeding, make sure the media player and any connected equipment are powered off and disconnected from the power source.*

Grounding terminal

# How to connect a R\_revolution NAS

If you own a R\_revolution NAS or any other NAS, please connect the devices as follows:

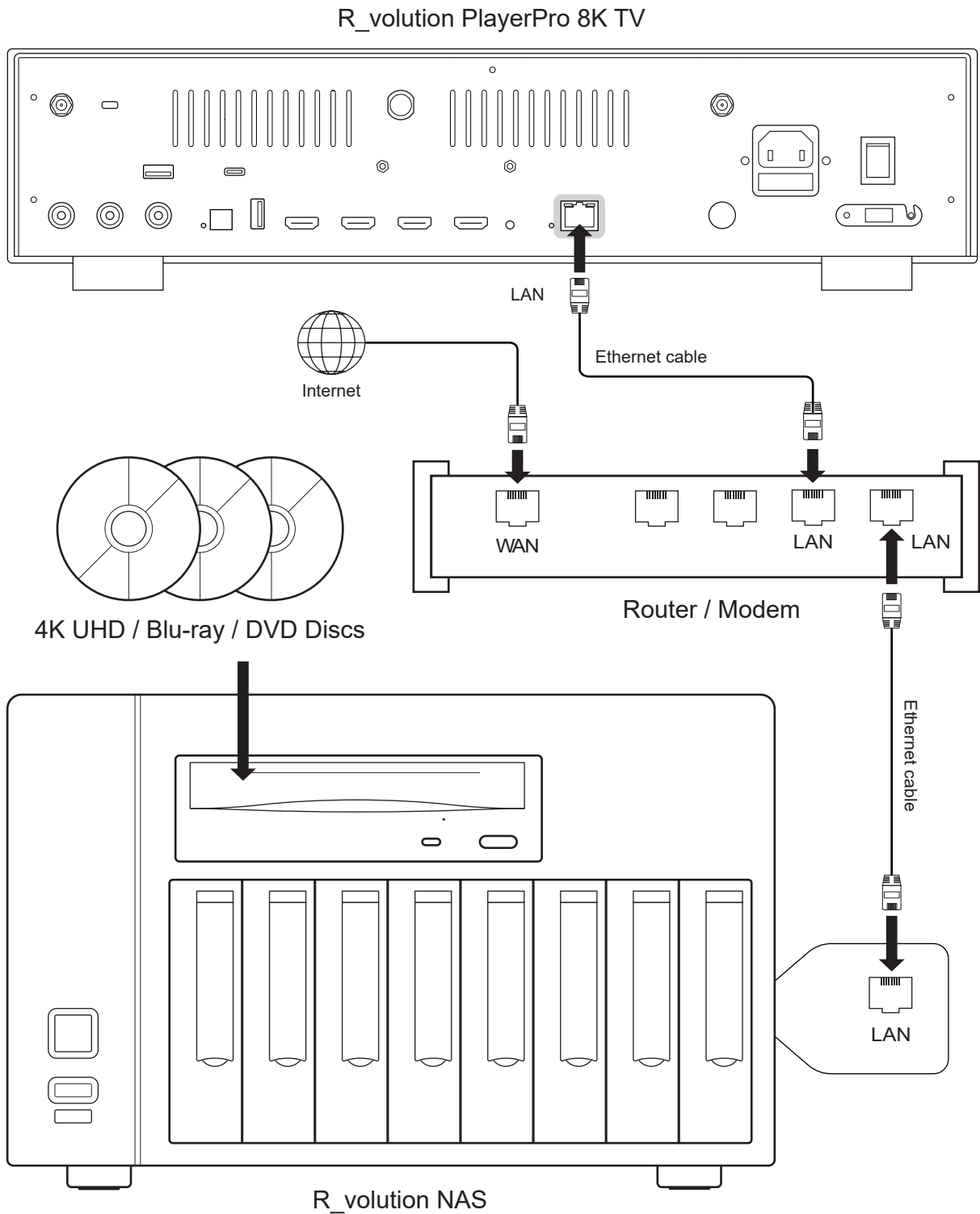

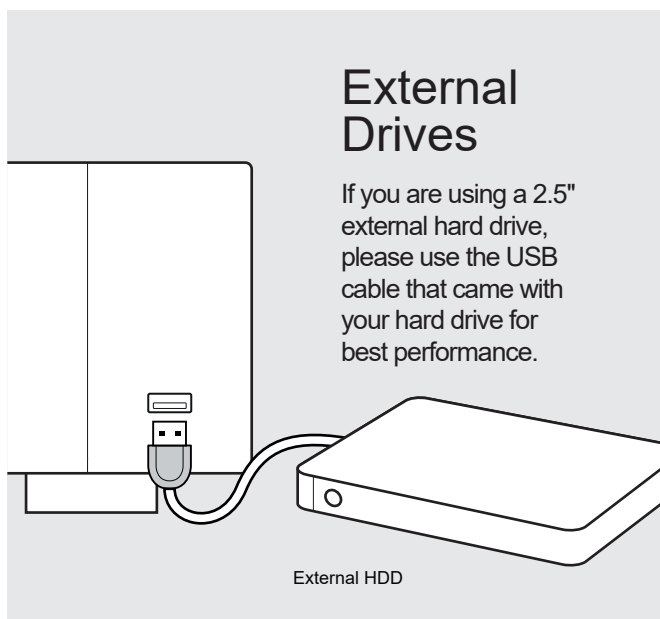

## Connecting USB Drives

Connect your USB drives to one of the available USB ports. If you want to play video files, USB 2.0 is enough to support very high speeds (up to 300 Mbps). If you want to transfer files, we recommend using **USB 3.0 ports for faster transfers**.

The power supplied by the USB ports may not be enough to allow the external drive to function properly; depending on the disk, especially for large capacity disks. In this case, please use a docking station.

*Please do not disconnect or turn off the USB external drive during writing operations such as copying or transferring files.*

*The media player is compatible with **UASP HDD docking stations** as well as **USB hubs**.*

## Using Internal Drive

To insert the internal 3.5 inch SATA hard drive, please open the rack door, then insert the drive into the internal case up to 3/4, then complete the installation by closing the door. This operation will complete the installation of the disk in the rack. The media player is compatible with drives formatted in FAT16 or FAT32 (read-write), EXT2/EXT3/EXT4 (read-write), NTFS (read-write), exFAT (read-write), HFS/HFS+ (Mac standard OS /Extended) (read-only), BTRFS (read-write). It is possible to **format** your hard drive via Explorer via **Menu > Format**.

More info: [rvolution.com/knowledgebase](http://rvolution.com/knowledgebase)

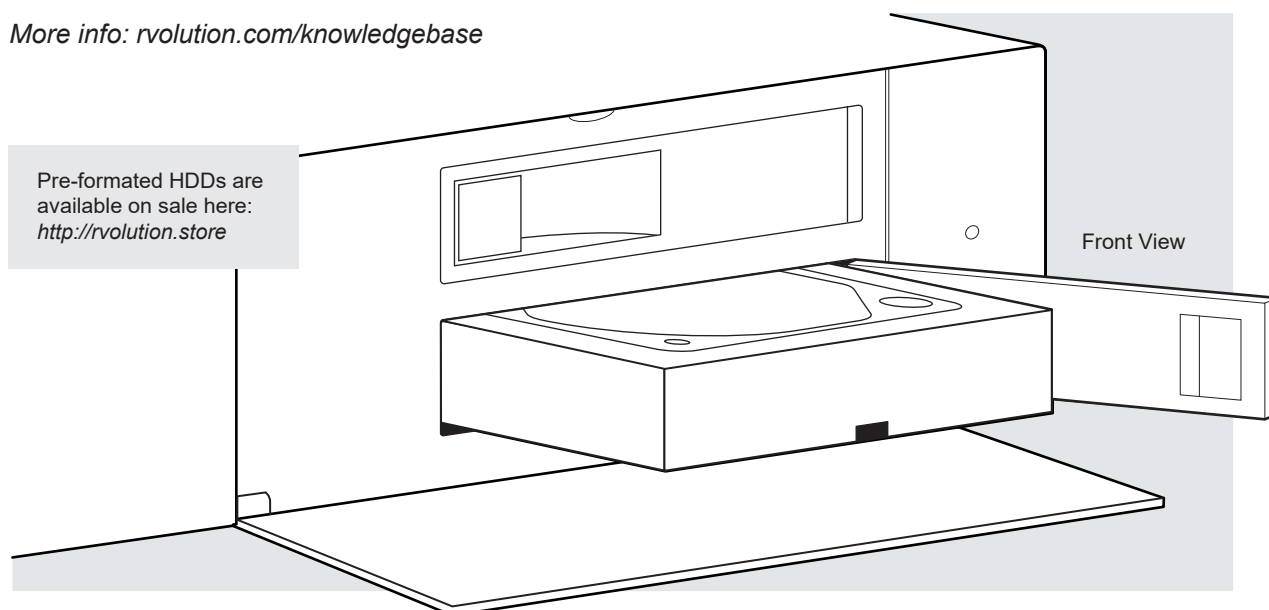

## Large capacity drives

The media player supports partitions up to 32TB. It can also format partitions up to 16TB via Explorer. To use hard drives larger than 16TB, use formatting software on your computer to format your hard drive.

## Getting Started

- ⚠ **Use the HDMI OUT output to connect your player to your TV or video projector.** Plug in and turn on the media player. The player will go through its initial start-up procedure (takes less than one minute).
- ⚠ **If you experience a black screen or no video signal, please consult the following knowledge base:** [revolution.uservoice.com/knowledgebase](http://revolution.uservoice.com/knowledgebase)

You will then be taken to a quick setup screen. Follow the steps to set the language, resolution, and network access.

Finally, you should see the main screen with access to the Video (R\_video Media Center), and Explorer applications, among others, as well as **Setup** and **Android Apps**.

To set the default language for audio tracks and subtitles for video content playback, go to **Setup > Playback** and choose your preferred default language for audio tracks and subtitles.

## Audio settings

The **Audio** section of the **Settings** menu allows you to set preferences for audio output formats. If you are using an HDMI compatible multi-channel AV receiver, please set the **Digital Audio Connector** option to **HDMI (HD Audio On)**. If your home theater amp / preamp is not HDMI compatible, set the **Digital Audio Connector** option to **S/PDIF (HD audio off)**.

We recommend that you set the **Digital audio output mode option** to **Auto**. But it may be useful to select PCM mode (with decoding) if you have a stereo-only amp or no amp at all. Bitstream mode usually sends the audio stream to your amp undecoded for home theater audio formats. For more exotic formats, the player itself decodes the audio formats using its **Dolby MS12 license** and transforms them into LPCM Multichannel or stereo which is transmitted in Bitstream mode. This is the case for example for multichannel audio formats in AAC, FLAC, MP3, AIFF or WAV. This powerful feature is one of the strong points of this player.

In order to listen to music in lossless or uncompressed format, you can set the **Maximum digital output sample rate** option to **192kHz**. However, please be careful because this mode can generate crackling in the speakers if you use an incompatible 192kHz amplifier or soundbar, or if you do not use an amplifier or soundbar at all (sound from the TV). In this case, select the **Auto** option.

## Video settings

By default, the player automatically adjusts the video output according to the resolution of your television. It is strongly recommended to leave the resolution settings in **Auto** mode (in **Setup > Video**). If your TV or projector is compatible, we recommend the **Y'CbCr 4:4:4 / 10-bit** or **12-bit** mode for the best video performance. **Warning!** *The higher you move up in the video output specifications, the higher the bit rate will be and will require a quality cable.*

### HDR

To benefit from the best performance on HDR content, we invite you to go to **Setup > Video > HDR and Dolby Vision settings** and select **Dolby VS10 processing for HDR, DV video**, in the **HDR processing mode** option instead of Auto.

# Android TV

To access video and audio streaming applications, go to **Apps > Android TV**.

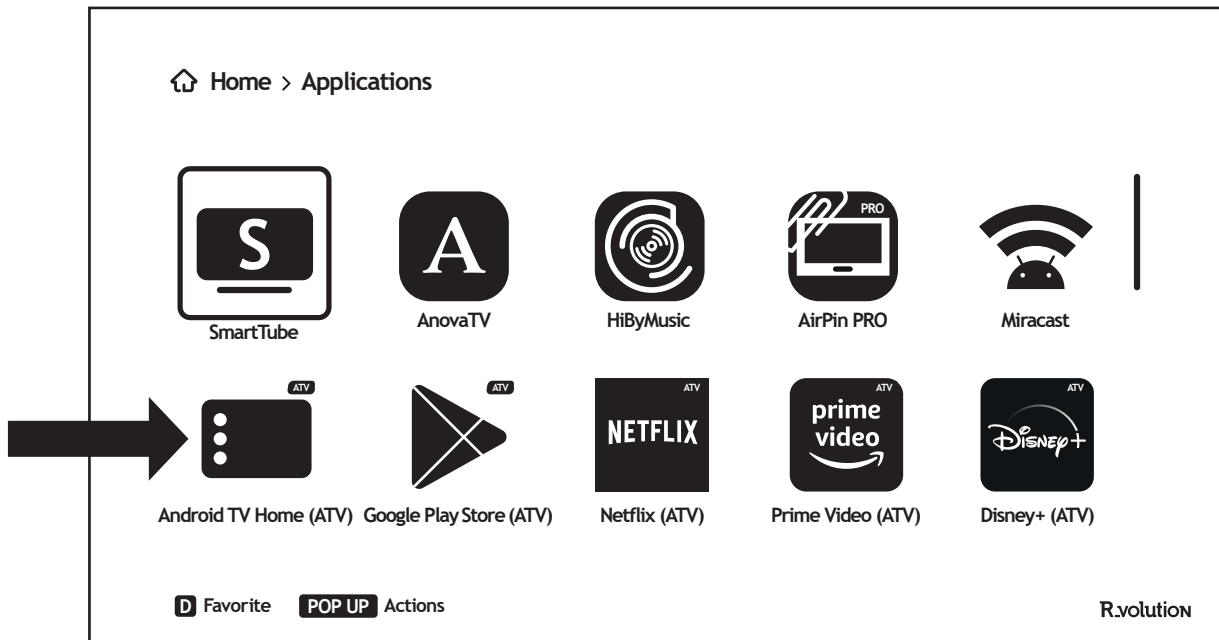

Main applications, such as **Netflix**, have a shortcut directly accessible from the Apps section. The first time you access Android TV, you will need to set up the device using the **secondary remote control**, identified by the **NETFLIX** logo.

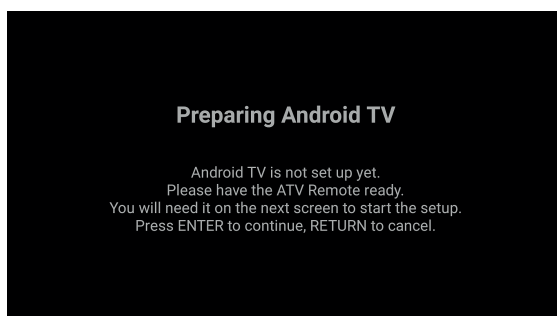
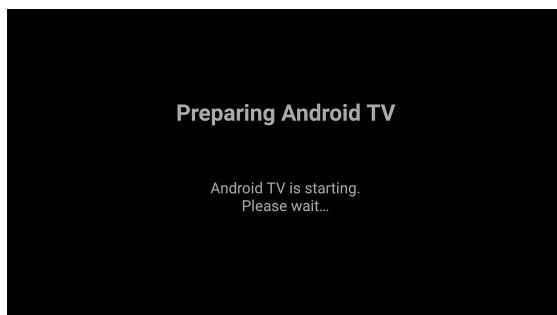

After the screens displaying the message “**Preparing Android TV**,” you will be prompted to press the **Left Arrow** and **Home** buttons simultaneously as shown in the diagram below.



Next, you will be prompted to choose your language. Then **follow the Android TV setup process** by simply following the **on-screen instructions**. At the end of this process, you will arrive on the **Android TV home screen**, where the most popular streaming apps are already installed. You may add additional apps if you wish. Video streaming applications do not benefit from the AI-PQ and AI-SR image processing features, but they do take advantage of the **linear power supply** and the **TCXO clock**. To enjoy Netflix in 4K 10-Bit HDR and Dolby Vision, the device must be set to 60 Hz (this is the default setting). Auto Framerate is not currently active under Android TV, but this feature may be added later through a firmware update.

Use the RC buttons UP, DOWN, LEFT, RIGHT, OK, RETURN to navigate through the player menu. Use the **MENU** RC button to show the list of available commands. Use the **INFO** RC button during playback to show the INFO panel (duration, resolution, framerate, bitrate, etc.).

The Home Page features 2 main applications: **Explorer**, and **Video**.

## Explorer

Explorer is a File Manager. You can easily explore and launch playback of your music, pictures and video content. But Explorer is more than just a file explorer — it also provides many advanced multimedia features and a complete file management system.

## R\_video

R\_video is a media player, software and entertainment hub, featuring an impressive user interface with movie covers. With R\_video, you can experience your entire movie and TV series collection, browse and play your titles from local and network storage media, view cast information, download subtitles, play trailers and much more.

In order to start using the R\_video app, you have to create a R\_volution account and register your device. First, connect your media player to Internet through Wi-Fi or Ethernet. Launch R\_video and select your language. Then, follow the on-screen instructions. If you have never used R\_video before and if you don't have any R\_video account, please click on **Create an account now**.

### Login

The login screen contains the following elements from top to bottom:

- An input field labeled "Email".
- An input field labeled "Password".
- A button labeled "Login".
- A button labeled "Create an account now", which is highlighted with a black arrow and the text "Click here to create a R\_video account".
- Two buttons at the bottom: "Return" and "Forgotten password?".

Then you will be prompted to enter your R\_volution Token number. The Token number is printed on a sticker located under the media player. You will only have to enter it once. Then all your account information will be saved in the internal memory of the media player. R\_volution needs this information in order to be able to register your collection (only the covers, not the films). The R\_cloud allows you to preserve your collection\*. In the event of a device failure, or the purchase of another R\_volution player, all you need to do is enter your credentials to access your collection and recover everything identically. R\_cloud also offers a multiroom feature called R\_share to access your collection of movies, concerts and TV shows from other R\_volution players in the house.

*\*for more info regarding the cloud service terms and conditions, please visit the official web site.*

## Accessing Network Drives and Access to the Player

This media player features a Samba client (SMB) to explore and playback your videos, pictures and music, located on your local network (NAS, computers, ...). The SMB Server is activated by default. You can access your media player entering **\\R\_VOLUTION** in the explorer of your computer or using the media player IP address as following: **\\192.168.1.15** (for instance). Then, enter **guest** as login and password. *In order to find the IP address of your player, go to: **SETTINGS / Ethernet Configuration**.*

More info about network access here: [rrevolution.com/knowledgebase](http://rrevolution.com/knowledgebase)

The media player also features a function called **R\_share**, based on Samba server technology. This allows you to access your video, pictures and music content, located on internal HDDs (or local drive connected in USB to the media player) from another R\_volution player through your local network. You can playback video contents, in up to 5 different rooms simultaneously (up to 2 in UHD resolution), equipped with R\_volution media players. Thanks to **R\_share**, a NAS server or computer is not required to stream your media content in different rooms in your home. To use R\_share, please select **R\_share** instead of **Local drive** in the **Folder settings** of **R\_video**.

## How to Transfer your Files Using Explorer

In addition to a file browser, Explorer is also a complete file manager offering functions such as: Copy, Cut, Paste, Select, Select All, Delete and Rename. To access these functions, press the **MENU** button of the remote control.

## Slideshow Function

Explorer also offers a slideshow function with cross fades and transition effects. To manage the **Slide show delay** and **Transitions effect**, go to **Setup > Playback > Photo Viewer**. To access the Zoom options, press **Zoom** button. Then, press **1 time** for **Fit to Screen**, **2 times** for **Pixel to Pixel**, **3 times** for **Custom options**. Then, use **P+/-** to **Zoom In/Out** and **Arrows buttons** to move the focus. Press **Pause** button to pause the slideshow and press **Play** to **pause/play** the slideshow. Press **OK** to display the list of the pictures and direct access to any one of them. On this screen, press **7** for **Repeat** and **8** for **Shuffle** options.

## Video Properties

To view the complete technical information of the file being played, press the **INFO** button on the remote control. You will find in particular, the datarate, framerate, video & audio codec and format, size, resolution, and more...

## Video and Audio Playback Options

During playback, the **MENU** button on the remote control provides access to various video and audio playback options such as direct access to a precise playback position in time, zoom and ratio options, etc.

## R\_volution NAS Stats & Options

The R\_video **MENU** provides access to the statistics of the R\_volution NAS (temperature of the drives, available space...) as well as music encoding options (MP3, AAC, and FLAC).

### Installing an App

To install an **Android app**, go to **Apps > Android TV**. You will be able to find many apps designed for media players and fully controllable with a remote. You can also use the **Google Play Store**. If you want to install an app on the Android section, you can do so via an **APK** from a USB flash drive using Explorer

### How to Add a Favorite

To add movie or a folder as favorite, press **Menu** and select **Add to favorite** to add it to the favorite section.

## How to Create a Movie Collection in R\_video

Before starting, you must create a folder named **MOVIES** on your HDD. Then, place all your movies inside this folder. If you have TV shows, place them in a dedicated folder named **TV SHOWS**.

### Movies

1. On your NAS or HDD, please create a movie folder named **MOVIES**. Place all your movie files in it.
2. Your files should be named with the title of each movie. For example, the file of the movie "Metropolis" should be named "Metropolis.mkv". You can create subfolders in the folder **MOVIES** if you want.

### TV Shows / TV Series

1. On your NAS or HDD, please create a folder named **TV SHOWS**.
2. Then, create a subfolder for each TV Shows. You can create a subfolder for each season if you want. Then, place all your TV Show episodes in it.
3. Your episodes must be named as: "TVShowName s01e01" ("TVShowName 1x01" also supported). For the special episodes, please name them as: "s00e01".

### Connection

Accounts	<input type="text" value="my.email@mailbox.com"/>
Servers	<input type="text" value="R_cloud"/>
Collections	<input type="text" value="Collection 1"/>

Start your player. On the main page, click on the first button named **VIDEO**. Choose your language and enter your login. *If you do not have any R\_video account, please go to the page 14.*

Then, click on the button **Connection** located on the bottom of the window.

On the **Folder configuration** window, please click on **Add a folder containing movies** (or TV Shows). If your files are located on a local storage, please click on **Local drives**. If you want to share your video contents with others R\_volution players through your local network, click on **R\_share**. Then click on the storage name. Next, browse it and go inside the Movies (or TV Shows) folder. Finally, when you are in the folder **MOVIES** (or TV SHOWS) click on **Add this folder** button located on the top of the window.

**WARNING! Do not add all your subfolders. You should just add your "MOVIES" folder containing all your movies. If you own a NAS, please place your folders MOVIES and TV SHOWS inside the shared folder VIDEO. Do not place your folders MOVIES and TV SHOWS in the root folder of your NAS.**

Your folder will be added in the MOVIE folder list (or TV SHOW). You can check the path by looking on the **generated path** located between "MOVIES" button and **EDIT** button. Your path should stop to the "MOVIES" folder (or "FILMS" folder). If your path is incorrect, you can modify it by using the **Edit** button. Press **Delete** button to delete the folder from R\_video. (*Don't worry! Your movies will not be deleted*). If you want to add another folder containing movies or TV Shows, please click on the dedicated button.

### Folders

<input type="button" value="Movies"/>	/storage/HDD/Films	<input type="button" value="Edit"/>	<input type="button" value="Delete"/>
<small>Storage ID: fs3sho54suey-ya55h4st7e-syot563lj3a</small>			
<input type="button" value="Add a folder containing movies"/>			
<input type="button" value="Add a folder containing TV shows"/>			
<input type="button" value="Add a folder containing personal movies"/>			

Then, press **RETURN** if you don't want to add another folder containing movies. R\_video will start to scan your folders and analyse your video contents. You can see the current scan task in a dedicated panel. To close the current task panel, press the **RETURN** button of your RC. If you close it, you can display it again through the **MENU** button of your RC.

**Done!** Now you can enjoy your R\_video collection! To access the configuration panel again, press the **MENU** button on your remote control. In the configuration panel, you'll find many options such as: language (GUI and identification), number of poster lines, top movie cover, parental control, identification on startup, terms to exclude, token and other account administration.

**More info here:** [rvolution.com/knowledgebase](http://rvolution.com/knowledgebase)

## R\_video

The R\_video homepage is made up of 2 parts. The left part offers access buttons to modules. By default, some modules are displayed, such as: **ALL, MOVIES, SERIES, RECENT, CATEGORIES, ...** It is possible to delete or add modules using the **MENU** button on the remote control. It is also possible to display the contents of a module or category of your choice in the main part (showcase). By default, the **NEXT** module is proposed. This module displays the movies or episodes currently playing. In case you have completed a TV episode, the following episode is proposed. In the case of a saga, the following movie is displayed. To delete an episode or movie from the **NEXT** module, select it and press the **MENU** button and click **Remove from Showcase**.

/storage/HDD/Films  
Storage ID: 0000000000000000

If you get a wrong storage ID with « 0000000000 », it means that R\_video cannot write on the drive due a defective disk sector. Please format it again.

To access additional features, press the **MENU** button of your RC.

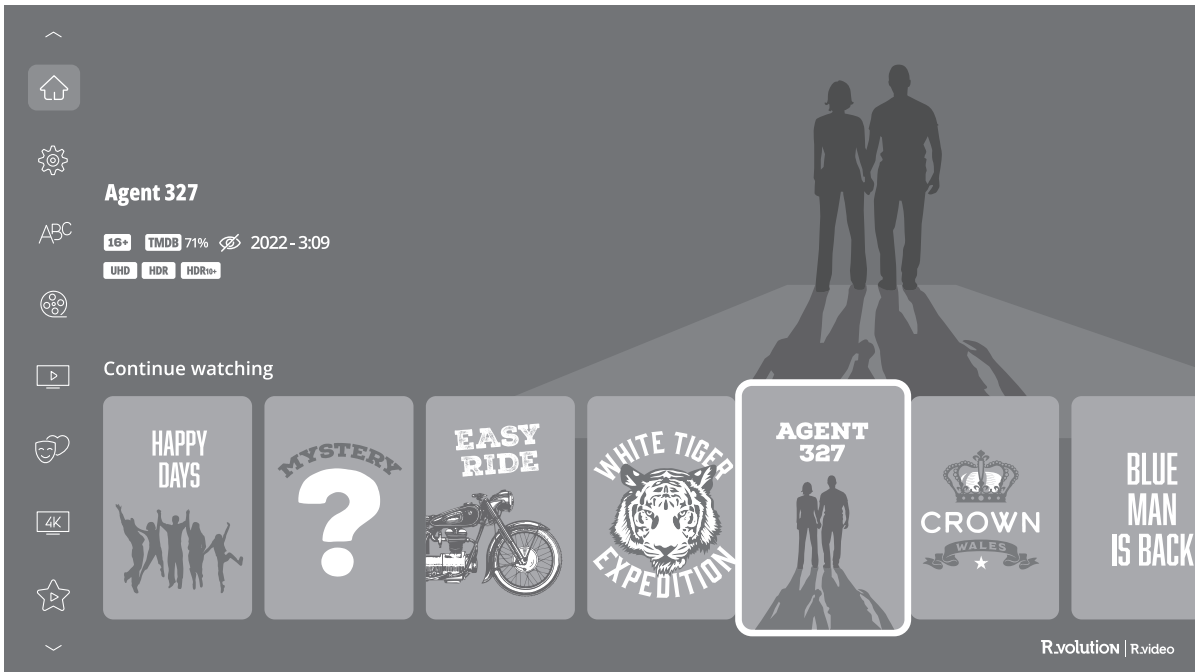



### How to Identify a Movie / Episode

When you add a movie file to your **Movies** folder, R\_video will automatically index it at the next restart of the application. To force the identification process, press **MENU** of your remote control, then click on **Identify** option.



#### Identification



-  Start identification ←
-  No video to identify

### How to Delete a Movie / Episode

When you delete a movie file from your 'Movies' folder, R\_video automatically removes its cover and descriptive page from your R\_video collection during the next analysis. You can manually remove a movie using the **Delete** option located in the R\_video menu (contextual actions).



#### Edition

-  Delete... ←
-  Categories

## How to Identify Unidentified Movies & TV Shows

Even if your files are not named correctly with the title of the film (or TV show), R\_video can identify it but only if a R\_video user previously identified it manually. If you are living in a country where R\_video is not yet popular, which could have happened often at the beginning, mostly if you are using a Rvolution NAS Rip because the generated files are rarely named correctly. But day after day, R\_video DB will become more and more reliable as users manually identify movies and TV series files.

Press **MENU** of the RC and select **X to Identify**. You'll see the list of the files that are not identified. Then, click on the button named **Identify...** On the **Identify window**, please enter again the movie title.

You can also enter the TMDb ID code to identify your movie or your TV show. On TMDb website, the ID code is located in the URL of the movie page. For instance, the URL of the movie "Charade" will be "https://www.themoviedb.org/movie/4808-charade". Enter the ID number "4808" in the dedicated field instead of the title. Then press the "Search" button. R\_video will find the right movie 100%. If your movie or TV show does not exist on TMDb, you can add it directly by creating an account. Please note that the validation of new film, concert or TV series listings on TMDb may take approximately 24 hours before appearing on R\_video due to the moderation period.

## Top Banners

A top banner is automatically added to 4K UHD, Blu-ray and DVD files. But you can add manually a special banner to the top of your movie covers. R\_video offers so many additional covers such as 4K Ultra HD Disc-1 / 4K Ultra HD Disc-2, 4K Ultra HD Director's Cut, 007, DC, THX, IMAX, DVD Special Edition, DVD Superbit, Laserdisc, D-Theater, etc.

To change the top banner, go to :

**Menu > Edit > Additional top banner > Custom.**

## How to Change a Picture (Poster or Background)

To change the poster or the background of a movie or TV show, press the **MENU** button of your remote control, then click on **Change the picture** option using the **OK** button of your R\_video remote control. Then, click on the poster or background of your choice. If you see a R\_video DB banner, it means that this picture is part of R\_video movie cover database.

## Multiple Hard Drives

R\_video is able to mix the content of several sources. For instance, one collection can contain movies located on 2 hard drives and one NAS. If you are using multiple hard drives, R\_video is able to detect if the drives are accessible or not. When you launch a movie but the drive containing the movie is not connected, R\_video will show a popup window asking to insert the dedicated drive.

## Parental Control

To tag a movie as **Allow for children**, select a movie (or a group of movies), then press the **MENU** button on the RC and click on **Allow for children**. Then, enter a 4-digit pin code.

### Parental code

Please enter a 4-digit pin code.  
This code will allow you to lock your collection and restrict access to movie tagged "Allowed for children".



## Personal Categories

By default, the movies and TV shows are automatically associated to categories. But you can create your own categories and associate manually your movies. To create a category, go to **Categories**, then press **MENU** and click on **Create a category**. Then, enter a name and choose an icon. The contextual menu gives also access to additional options such as: **modify the position**, **edit** or **remove**.



## R\_video On Start-Up

To activate this feature, press **MENU**, then go to **Settings**, click on the **second tab** and switch **ON** the option in the list.

### Auto-start

Auto launch R\_video on start-up  
↑

## Filter and Sort

To sort your movies, press **MENU**, then go to Filter and sort. Then click on the **first item**. Then select the sorting: **A to Z**, **Z to A**, **Release date**, **Ranking**, **Duration**, **Addition...** The new sorting bar will appear on the right of the cover list. To filter your movies, please click the following options: **Seen**, **Ongoing**, or **Not seen**.

### Filters

 Decreasing Release date  
 Seen videos  
 Ongoing videos  
 Not seen videos

## Search Engine

To search for a film, saga, TV show or content with a specific actor or director, click on the **Search** button located in the left bar. Then enter your search (**title**, **actor**, **director**) with a minimum of 3 letters, then validate. The results will be filtered by **films**, **TV shows**, **sagas**, **actors** and **directors**.

## Sagas / Groups

The films from sagas are automatically placed in groups and sorted by release date. A saga cover dedicated to the collection is associated with the group and movies are displayed in a dedicated horizontal scroll list.

## Subtitle Display Options During Playback

To change the subtitle display options such as vertical position, size and color, press the **Subtitle** button on the R\_volution remote control during video playback, then go to **Settings** and change the desired option. To change the **vertical position**, use the buttons **UP / DOWN**. To change the **size**, use the buttons **P+ / P-**. To change the **color**, use the buttons **1-6**. To add external subtitle, please use the same name as the video file as follows: *Metropolis.mkv / Metropolis.srt*

## Subtitle Download Option

To download subtitles, go to the desired movie, concert or episode, then press the **MENU** button on the remote control and click "**Download subtitles...**".

## Zoom and Aspect Ratio Settings During Playback

To modify the aspect ratio or zoom the image during playback, press the following button: 

## Media Info During Playback

To display the media info and various info such as bitrate, resolution, requery, etc., please press the **INFO** button during playback.

## R\_video Collection Statistics

If you want to display the statistics of your collection, press the **MENU** button on your remote control, and go to **Information > Collection Statistics**.

## Add a Category in the Left Bar

On the R\_video home page, go to one of the modules in the left bar. Then, press the **MENU** button on your remote control and select **Add module**. Choose from the list of modules the category you want to highlight in the left bar. You can then modify its position in the left bar if needed.

## Token Error Message "Account / token already used"

When you encounter the message **Account / token already used** you need to release the token in order to use it. If you are not able to do it by yourself, contact us by sending us a photo of the sticker under the media player with the token number. We will release it for you.

## Firmware Upgrade

Usually, if a new firmware is available, you will be informed at the player's startup. To access the Firmware upgrade page and manually launch the online firmware's update, go to **Setup > Miscellaneous > Firmware Upgrade**. You will see the current firmware version. Click on **Check Available Update**. If a new version is available, you will be able to download it and install it. If there is no new firmware version available, a popup windows will appear to confirm. To manually upgrade the firmware using a USB flash drive, please visit [revolution.com](http://revolution.com) > **Download > R\_revolution PlayerPro 8K Firmware Updates**.



### DISCLAIMER

On some cases — especially if you come from a more recent firmware — during the process, the TV screen can switch to **GREEN** or **BLACK** for a while. This is normal! Please absolutely not restart or switch off your player during the full process. In such case, please wait 10 min before to restart your media player.

## Factory Reset

In case of problem try turning off your media player and unplugging the power cable for 10 minutes. It could solve the problem. If it does not help, please try the following procedure. Be careful, however. This will reset all your settings and account information. But you will not loose your movie collection.

1. Go to **Setup > General**
2. Click **Reset Settings** button, then click on **Reset settings** to confirm the procedure.
3. Please wait during the reset process.

**Warning!** Do not restart or switch off your player during the full process

## Hardware Reset

If you do not get any video signal, you can boot into Recovery menu:

1. Start the media player.
2. During power-on press and hold the **Reset** button located on the back of the media player using a paper clip.
3. Then do "**Wipe data**".

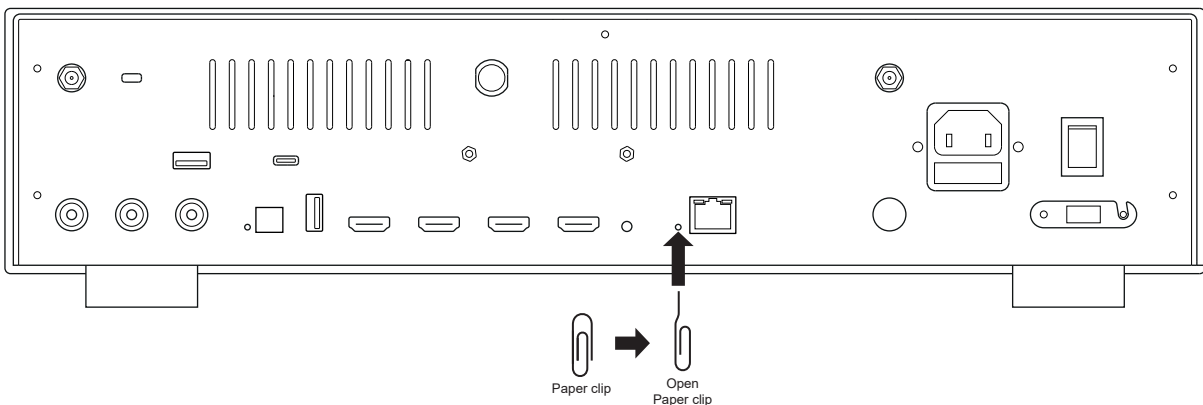

# **R.volution**

[rvolution.com](http://rvolution.com) / [rvolution.store](http://rvolution.store)